

Standard building size

clear opening

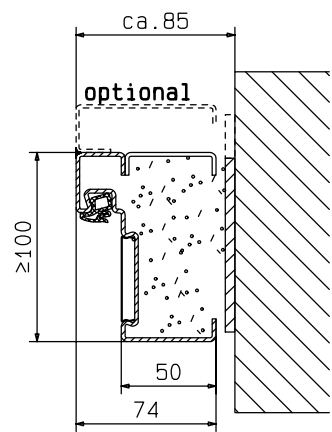

main frame "ZNG 68/76"

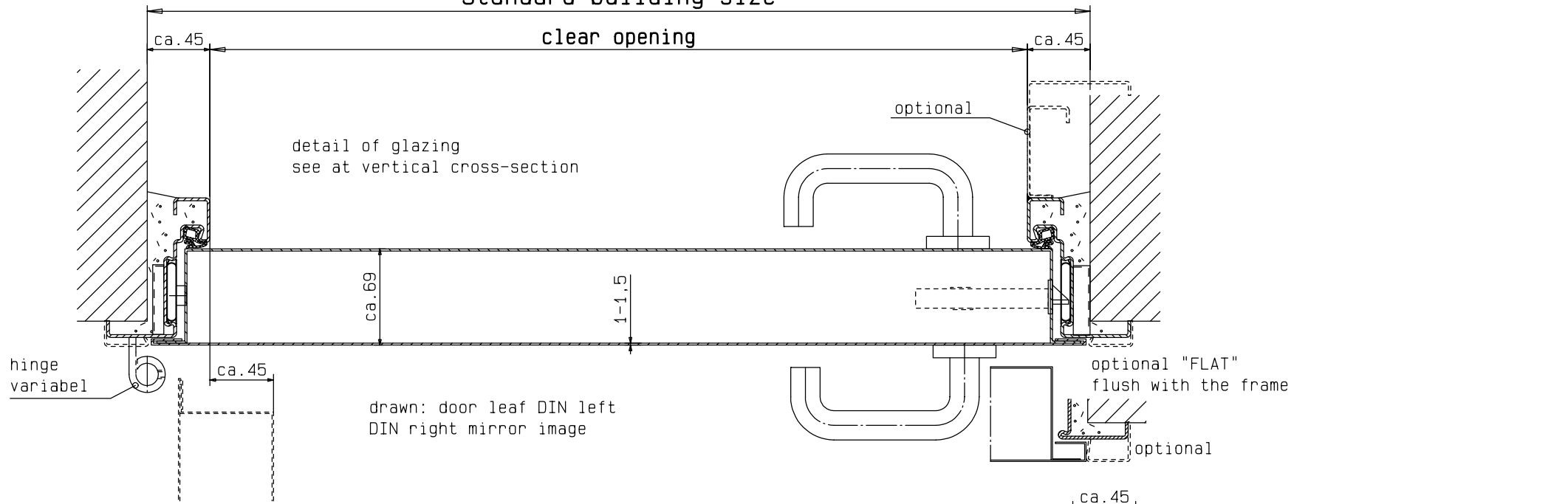
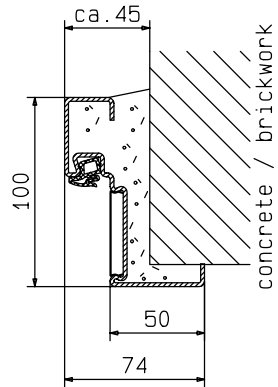

optional frame "ZNG 58/76"

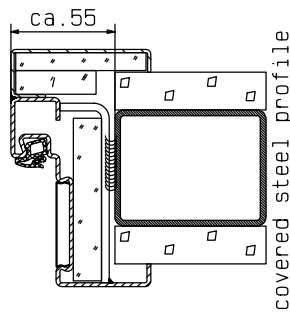

covered steel profile

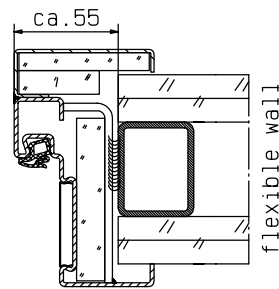

flexible wall

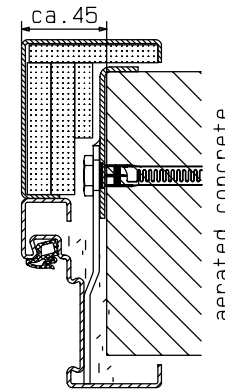

aerated concrete

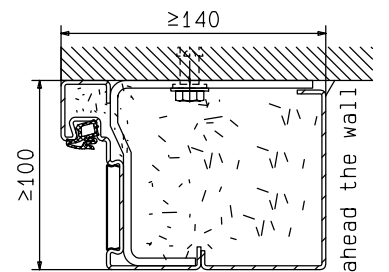

ahead the wall

System Schröders
Innovation Tür und Tor

Gerhard-Welter-Straße 7; D-41812 Erkelenz

single leaf steel fire door
EI260/E60/EW60-C5-S2(S200)
"System Schröders TSN-3"
horizontal cross-section

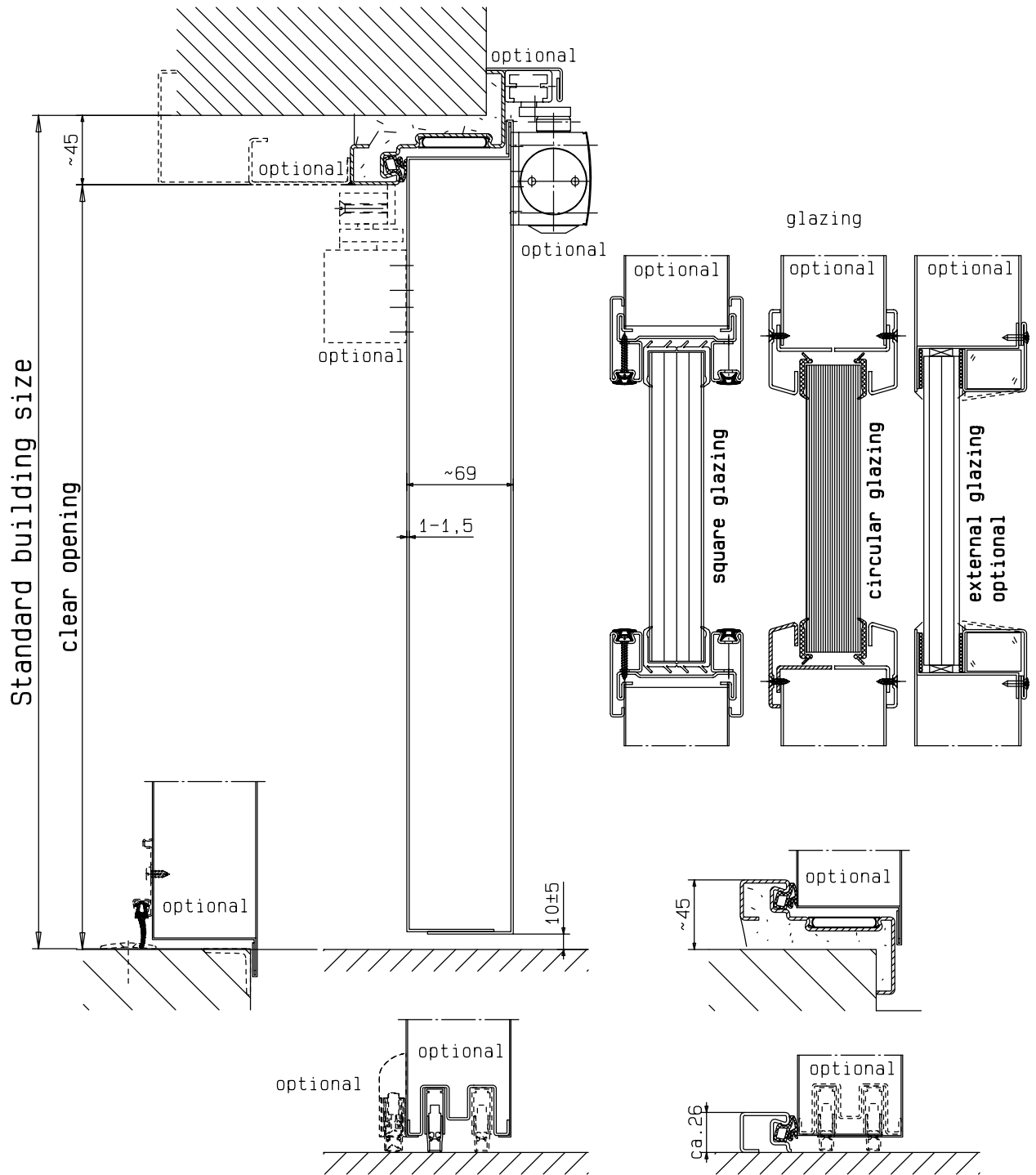

Also deliverable as an external door
CE-marked according to EN 14351-1

details of fitting or frame
see at horizontal cross-section

System Schröders
Innovation Tür und Tor

Gerhard-Welter-Straße 7; D-41812 Erkelenz

single leaf steel fire door
EI₂60/E60/EW60-C₅-S_a(S₂₀₀)
"System Schröders TSN-3"
vertical cross-section